

ATHENA₂₀₁₂

The AutoCAD application for curtain wall design and façade engineering





There are two key ingredients necessary to design impressive façades that function well. The first ingredient is a capable designer with experience and a knack for technically ingenious solutions. The second is a powerful CAD application that is precisely tailored to the designer's requirement and provides the support for professional, error free designs that require less work and are delivered on time.

This is where we call upon our AutoCAD application, ATHENA, the all-round software solution for design in

- metal and facade construction
- curtain wall and shopfront construction
- glass construction
- industrial construction
- lightweight steel construction.

Ideal for international design: ATHENA labels all the customer objects fully automatically and is able to translate a drawing into each of the eleven languages currently contained in ATHENA on the press of a key.

ATHENA is the leading design software for curtain wall design and façade engineering on the market—and not without reason. Our software has been subject to consistent on-going development for more than twenty years and is used in metal construction companies, design offices and universities—in eleven languages and more than thirty-eight countries.

Matched exactly to our users' requirements, ATHENA is a complete software package, offering practically everything to simplify the daily design tasks that confront the designer:

- A 2D drawing environment with practical routines and libraries for producing elevations, cross-sections and workshop drawings.
- A versatile 3D design section with the possibility of producing parts lists and production drawings directly from the 3D design.
- Powerful computational tools for structural analysis and building physics.
- A sheet editing program for sheet design and development.

In addition, ATHENA is independent from specific aluminum manufacturers' systems and can be matched to individual needs.

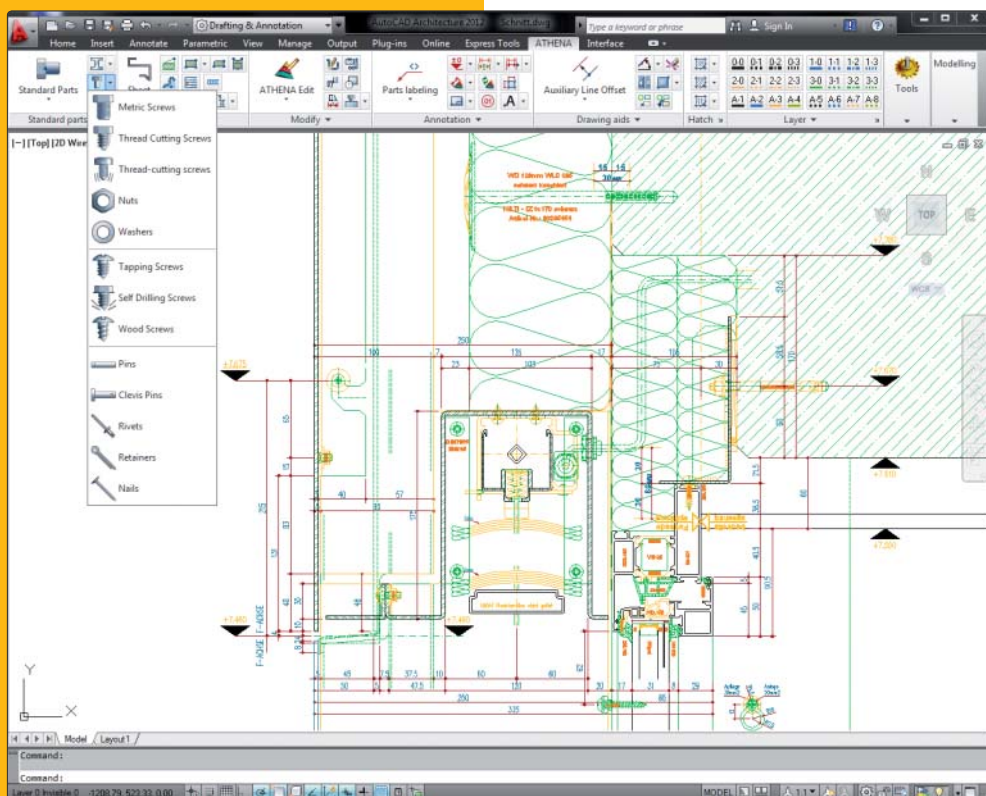

Four-way versatility!

ATHENA contains four functional groups covering a range of performance for which you would have to procure four different programs.

Functional Group 1: 2D design

2D drawing functions are tuned for the rapid production of section and elevation drawings, plan views and production drawings. Features particularly promoting productivity include routines for semi-finished items, membranes, thermal insulation, panels or welded seams plus a comprehensive standard parts library with 80,000 parts or the tools for managing materials, layers and blocks. A special advantage is that all ATHENA objects are intelligent ARX objects and can be edited with a double click!

Functional Group 2: 3D design

The 3D design is used for the free planning of complicated geometries, such as, sloping polygon façades, pyramids, glazed roofs and bays. To achieve this, profiles or profile groups are placed over the axes of a wire model. Cut parts can be automatically computed and the components (e.g. profiles) are output with the cut parts in a parts list or in a drawing. Dedicated master data can be created, containing the profile geometries, material properties, design rules or requirements from production. Based on this master data, as well as spatial elements you can design flat elements, such as windows and doors. The 3D design takes into account profile groups, cut parts, processes, sheet metal, glazing and also hardware. It can be displayed as a 3D view, 2D view and through any sections. The extracts can be output as parts lists or as production drawings. An interface to calculation programs and PPC/ERP is available.

Functional Group 3: Sheet editing

ATHENA now contains a complete sheet editing program for the quicker design of sheets with the associated developments. Increased productivity during sheet design comprises of clearly laid-out dialog boxes for the input of basic sheet data and processes, a 3D viewer for continuous visual checks and versatile options for the import and export of drawing data.

Functional Group 4: Engineering

Always on the safe side. ATHENA's computational functions for structural analysis and building physics are well-developed tools for the exact determination of, for example, centers of gravity and moments, thermal resistances or sound insulation dimensions. You can conveniently compute the required moments of inertia or maximum deflections. You can also carry out thermal bridge analyses (isothermal calculations). In this way thermal bridges can be eliminated during the design stage.

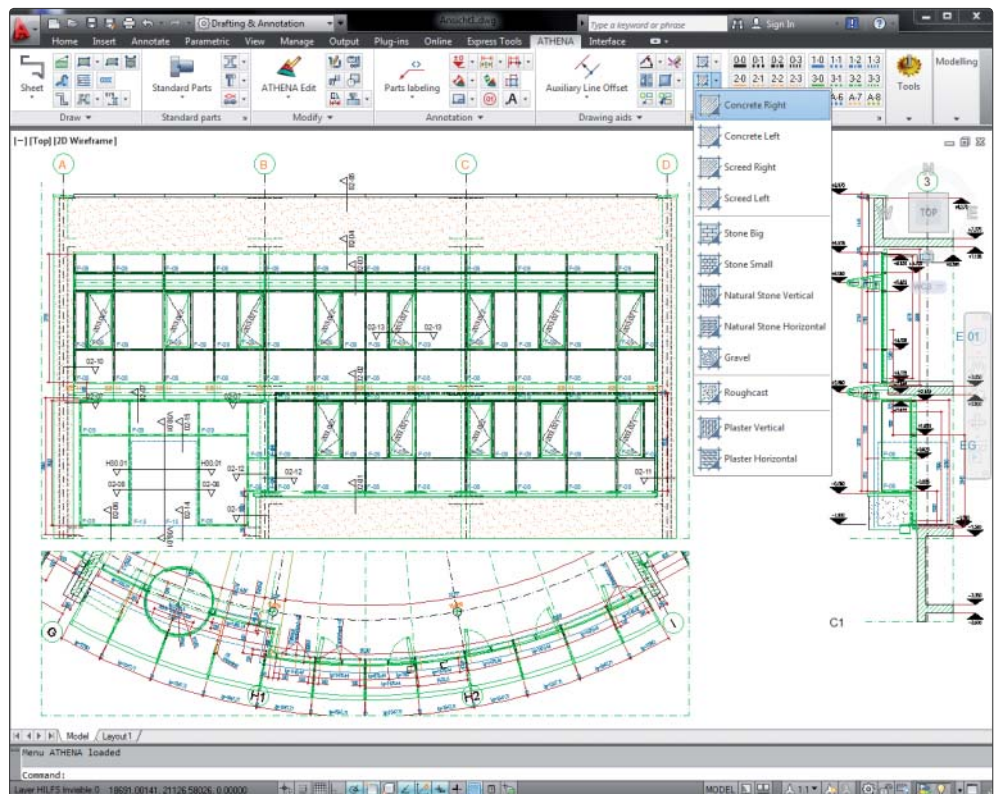



2D DESIGN

Classical two-dimensional construction takes up a particularly large part of the designer's workday routine—drawing views, generating cross-sections, drawing up detailed drawings, producing manufacturing documentation. The optimization of the work procedure with a special software solution leads to increased productivity and a higher-quality finished product. This is a big advantage for the designer who is no longer impeded by the limitations of the working tools and has a powerful assistant at his side to relieve much of the work.

ATHENA has proven its capabilities over years and the 2D section especially profits from careful maintenance and on-going development.

Numerous routines simplify the drawing of panels, insulation, membranes, welded seams, sheet or glazing cross-sections. Clearly laid-out dialog boxes gather important information and with the positioning aids the object is conveniently placed in its position in the drawing. ATHENA handles everything else.

Many vast built-in expandable libraries make light work of inserting objects into the drawing, e.g. profile systems, standard parts or screws and other hardware. Various international standards are also provided.

Dimensioning also becomes a pleasure with ATHENA: Efficient incremental dimensioning, arc dimensioning, levels—and of course interrupted di-

menting, which is passed on associatively with changes in geometry. All ATHENA objects are ARX objects and can therefore be edited with a double click. Object labeling is automatically adapted for changes of dimension.

The powerful 2D tools of ATHENA increase productivity, save work time and costs plus also help the designer to concentrate on the essential aspects of his work.

Maximum efficiency for your plans and drawings

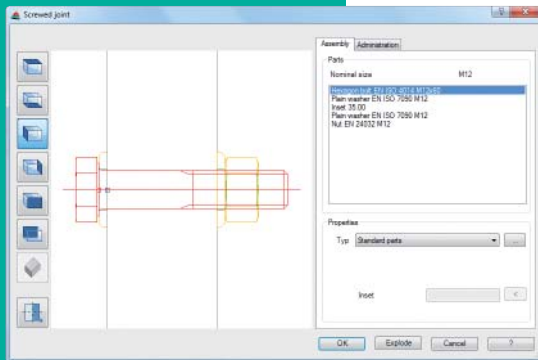

Screwed assembled joint

ATHENA has a program for generating screwed assembled joints. Screwed joints consisting of a number of ATHENA parts (screw, washer, nut, hole) can be generated and also edited. Frequently used screwed joints can be saved in libraries for repeated use. Screwed joints can be inserted into the drawing in 6 different views and also as 3D objects.

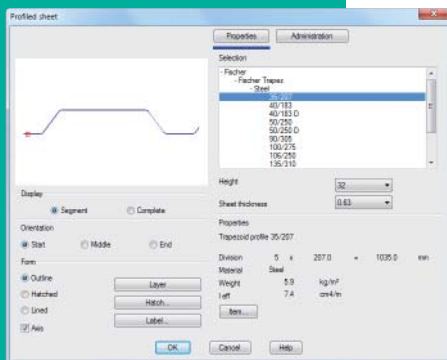

Profiled sheet

The profiled sheet generator facilitates the fast insertion of trapezoidal or corrugated sheets from various manufacturers. The sheet parameters are defined in a dialog box.

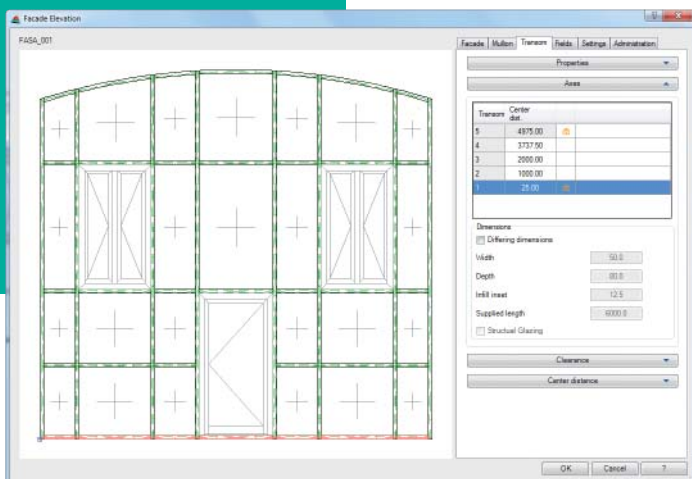

Elevations

ATHENA offers a number of commands for creating views. Façade and element views can be easily created and modified later.

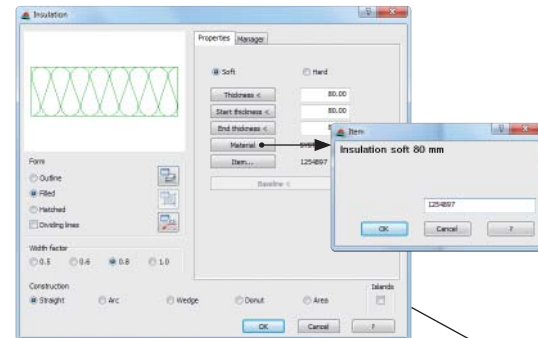

Thermal insulation

Regardless of how the insulation was created, it can be altered using grips or the stretch command, and made to fit an irregular area. The insulation depth can be specified independent of the thickness of the insulation mats. Insulation can be displayed as soft or rigid. The most varied shapes are possible: Straight, curved, wedge-shaped, annular and flat, also with islands.

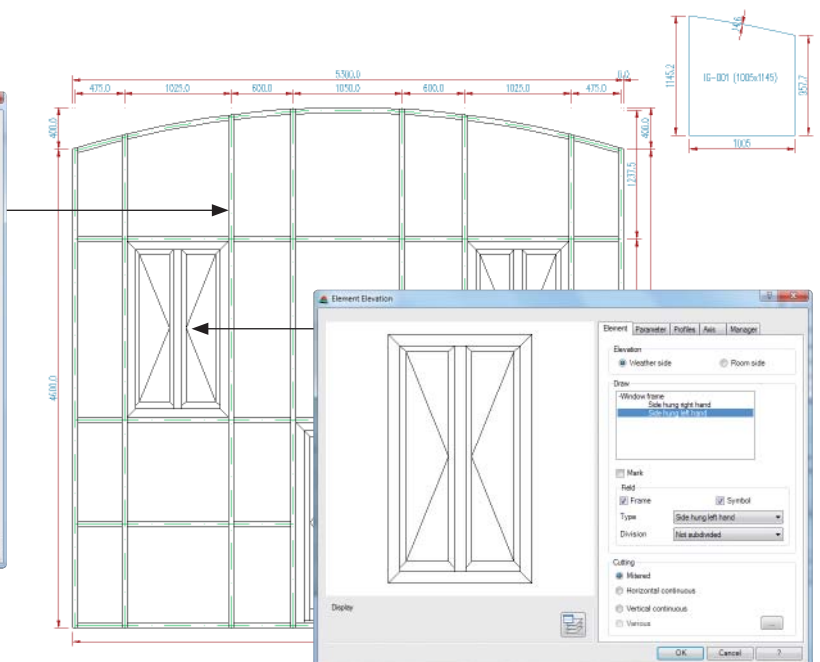

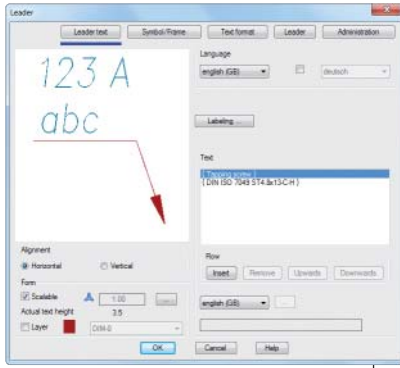

Parts labeling

All parts are intelligent and can be labeled with leader arrows. Leader texts are automatically adapted when the labeled part is changed.

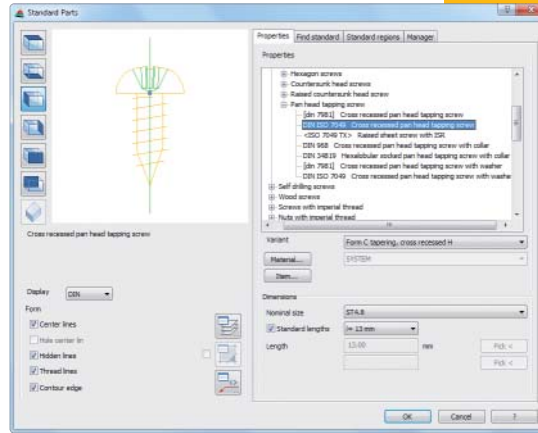

Standard parts

Standard parts complying to DIN, ISO, EN, GOST (Russian), GB/T (Chinese) and AISC (USA) are available. Parts can be selected from previews or lists in the dialog box. You can choose to label the part and to display centre lines. Standard screws are stretched in standardised increments, but non-standard lengths are also possible. Currently, there are about 80,000 parts available which can be handled conveniently via find and filter functions. Standard parts can be inserted into the drawing in 6 different views and also as 3D objects.

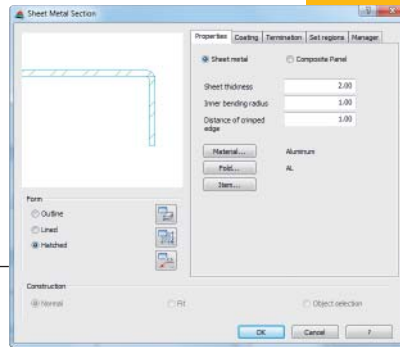

Sheet metal section

You can create material specific sheet metal sections. The limbs can be straight or curved. The sheet development programs allow a material specific development of the section to be created and also generates cuts in composite boards.

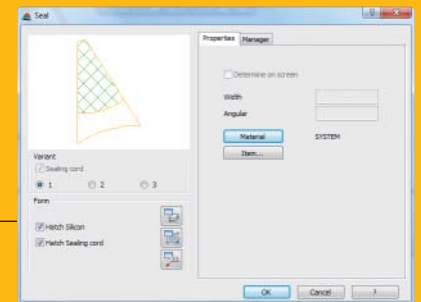
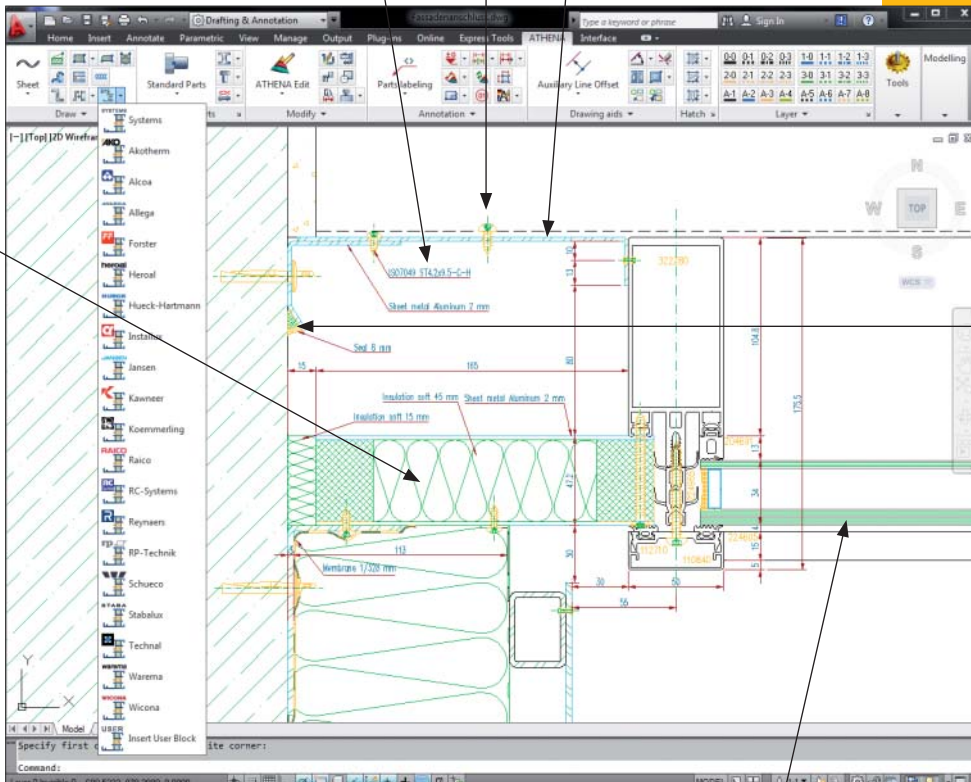

Silicone sealant

To create silicone sealants, click on two lines (or polylines) to create a silicone sealant between them. This can then be pulled to shape using grips.

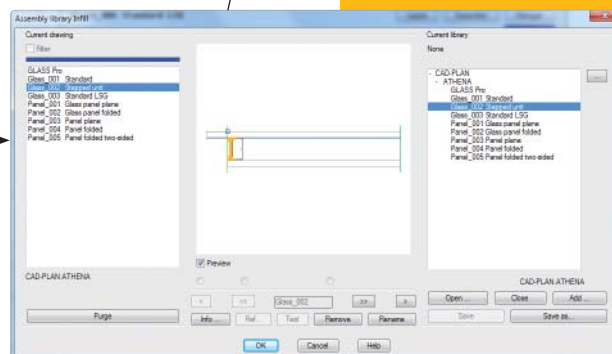
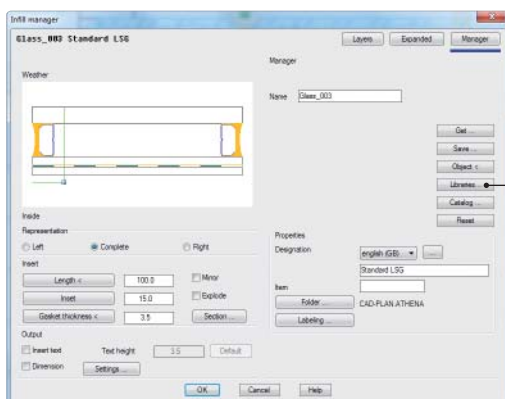

Management of filling properties

The management of any type of filling, e.g., glass, metal panel or stone, occurs in a dialog box. The filling properties can be saved in a data base and then used in any drawing of the 3D module. Complex infill, such as coated or offset glazing, is possible.

3D-DESIGN

Never before was the three-dimensional design of façades so easy. Sloping polygon façades, pyramids, glass roofs, bays and other complicated geometries can be quickly generated without complication. The automatic generation of cut parts saves a great deal of time and effort.

As a basis for the production of extensive 3D designs an axis model is used, to the axis lines of which single profiles or complete assemblies can be placed. With a simple function an analysis of the axis model can be carried out in ATHENA in which also the weather side is defined. Thereafter ATHENA recognizes all the angles, field quantities and alignments within the axis model. Consequently, in conjunction with the application of the designer's own assemblies a high level of automation can be achieved. For example, you can create a mullion and transom façade with all cut parts at inconceivable speed.

Only a few working steps are necessary to provide an axis model complete with profiles, to generate the cut parts and the façade elements, also simultaneously provided with fastening components, holes and screws.

Functional dialog boxes facilitate the rapid composition of assemblies from a number of profiles, e.g. mullions or transoms with associated covering strip, insulator and rubber seals. These assemblies can be saved in libraries in the 3D design as well as in the 2D sectional plans. Insets defined in the assemblies for infill's make the insertion of glazing or paneling a simple and quick process. Also, you can assign to the assemblies fastening elements with holes or screws, which ATHENA can then automatically transfer to the bar joints in the 3D design.

The ATHENA 3D function is designed to prepare a complete façade for production. The production documentation for the generated components can be output as a drawing with automatic dimensioning and as a parts list. Here, the profile cut parts including the jack rafter sections and processes are taken into account. Apart from the profiles, sheets and glazing, the parts list also includes all the hardware, e.g. joint components and screws, and it is structured, so it is also suitable for transfer to cost calculation and ERP/PPC systems.

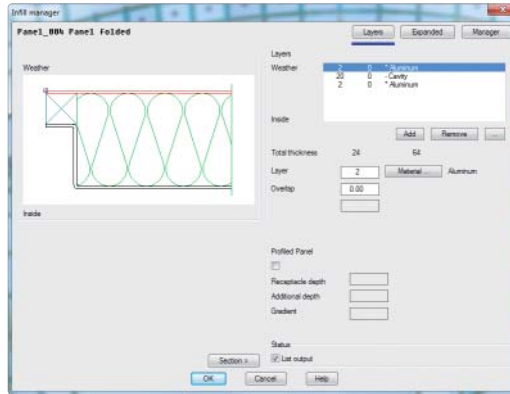
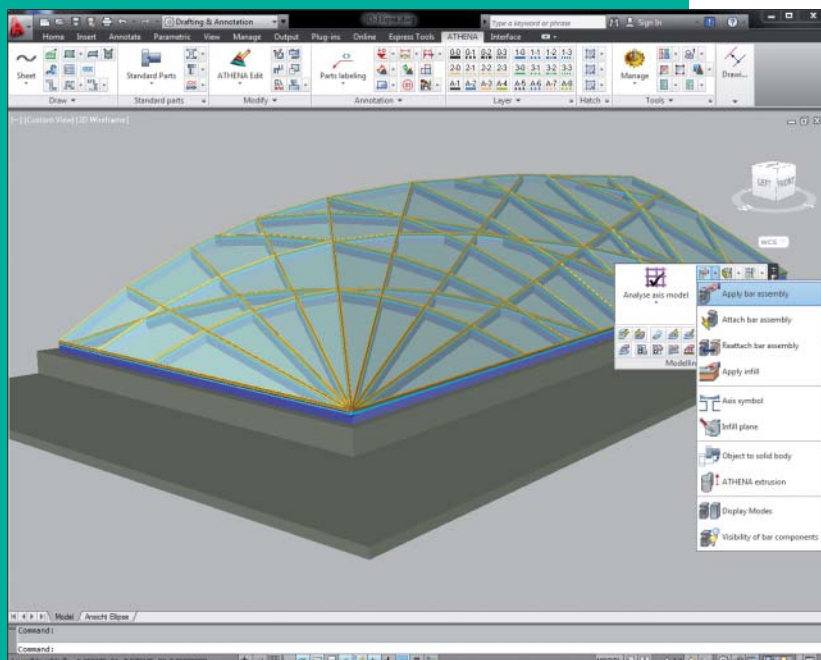

Infills

You can create infills, e.g., panels that can make up several layers. The infills are assigned to boundary objects, for instance mullions and transoms.



Apply infill

When an infill is assigned, the insets are quickly and easily defined. The inset can be different for each edge, and also different for each layer. In this way, notched glazing can be created.

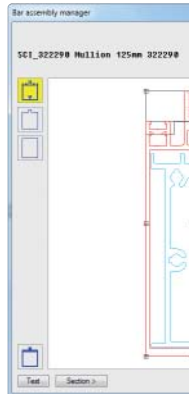

Create Assemblies

The Bar Assemblies consist of a number of profiles to form a complete assembly. Components like insulator and rubber seals can be added. Components can be rotated and displaced.

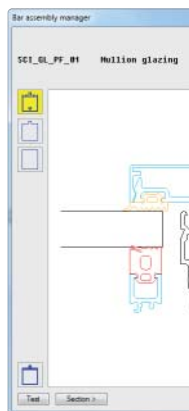

Glazing

A glazing assembly can be composed of mullions and transoms. The mullions and transoms can be different, which is particularly true for transom profiles where they are not the same. Also different glazing can be used in a façade.

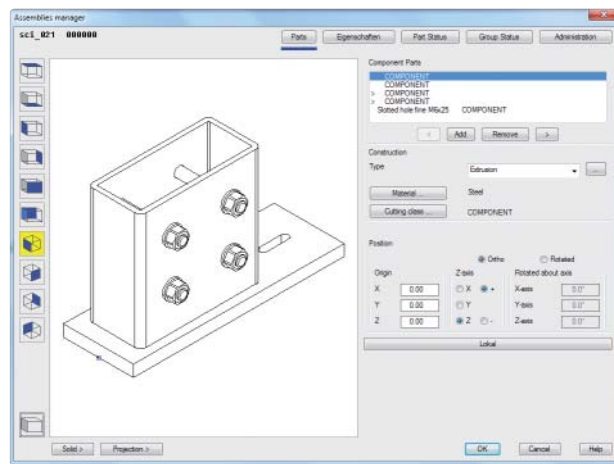

Apart from bar-shaped 3D assemblies (e.g., profiles) and area objects (e.g. glazing or panels), now local assemblies, i.e. joints and processes such as glazing retainers, can be generated. All ATHENA standard parts (screws, nuts, etc.), holes/elongated holes, sheet cross-sections and customized contours can be applied. The assemblies can be positioned on 3D profiles singly or according to

a grid. during In the s accord details

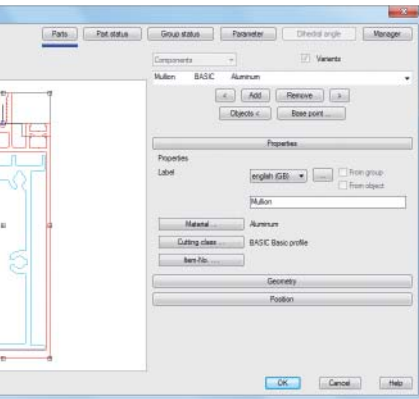

Parts Manager facilitates the grouping of a number of parts into an assembly, e.g. a Transom with sealing and cover section. Within an Assembly, the parts can be modified or reassigned. Also, the components can be mirrored, and the insertion points can

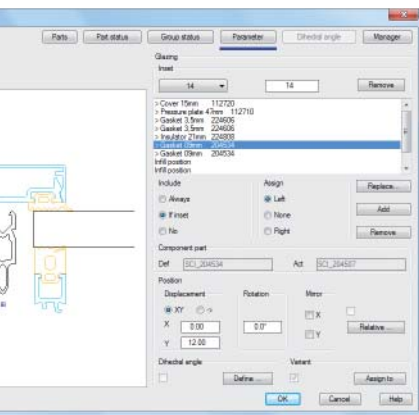

with cover section, insulator and rubber seals can be defined separately from the basic design. Mullions can be defined separately and assigned to this assembly in the 3D design, which is very advantageous when different mullion and cover sections are used in the façade, but the glazing is always the same. Different mounting thicknesses can be realized

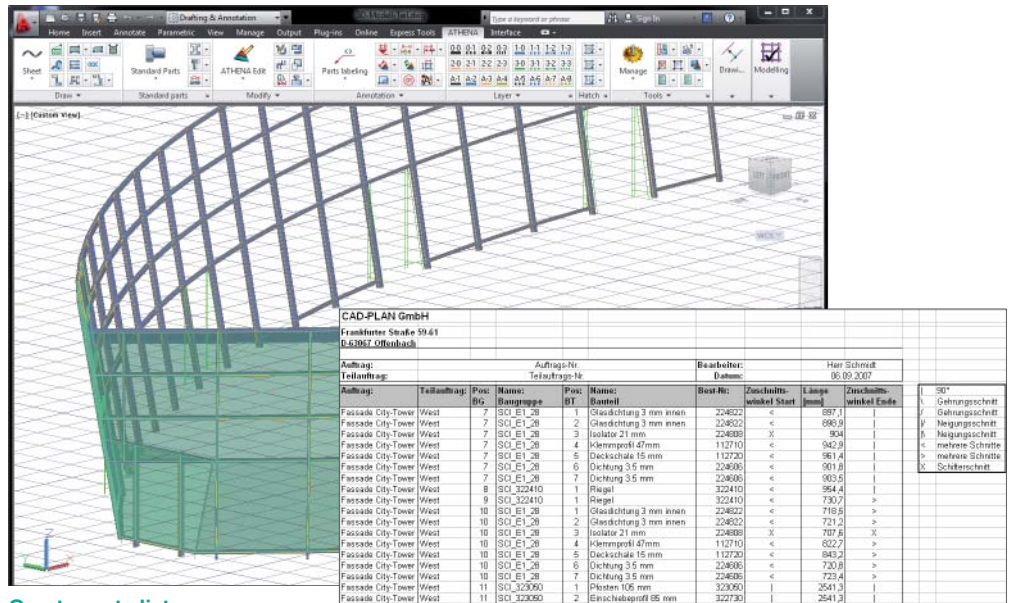

Create parts lists

Parts lists can be created directly from the 3D drawing from all parts used in the construction. Infill lists and bar lists, including raw and cut lengths of the profiles, can be created. The lists are created in MS-Excel/Access format.

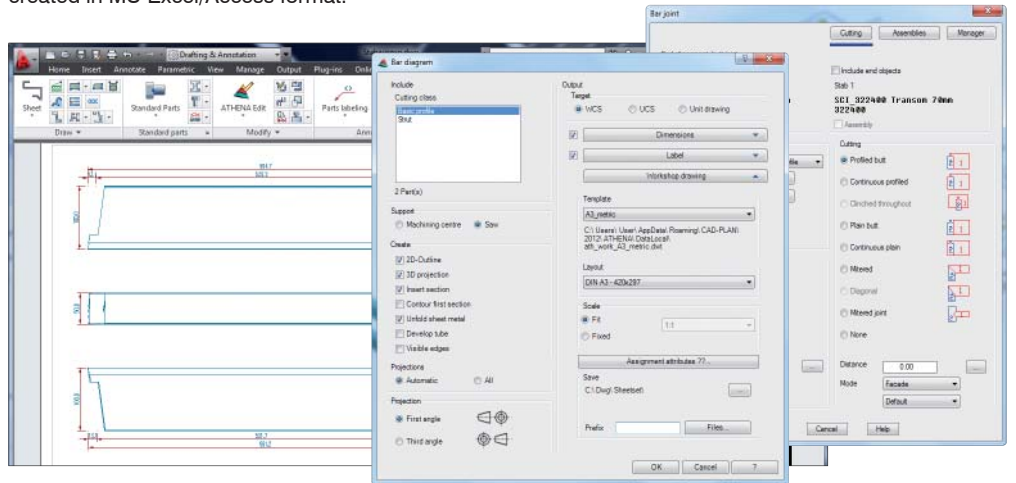

Bar diagram

After the automatic profile joints (cuttings) routine has been run, bar diagrams can be produced. A 2D bar diagram of the profile with lengths, angles and part numbers is automatically created.

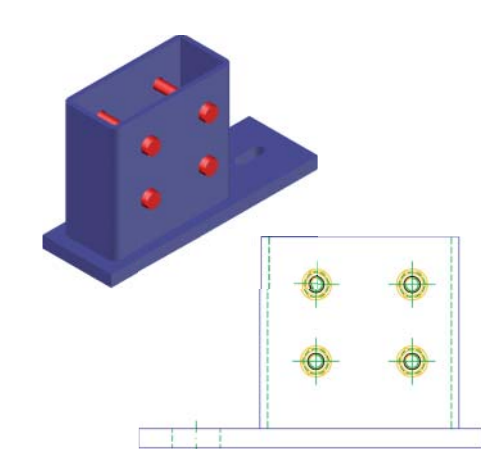

The parts of the assembly are also positioned in the 2D evaluation (projection) of the 3D profiles. In the structured parts list the assemblies are ordered according to the profile or the infill, which facilitates a detailed evaluation in ERP systems.

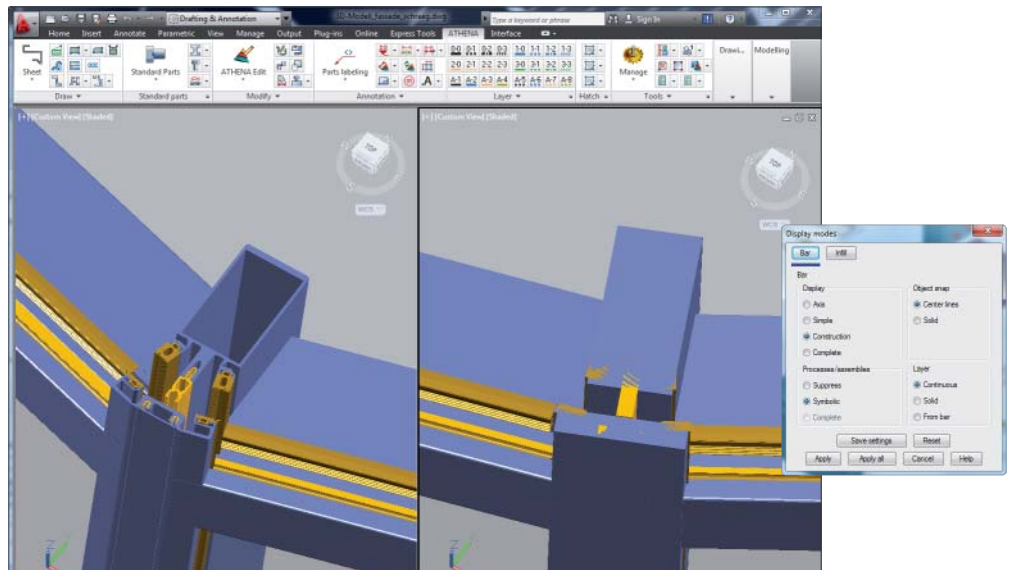

Simplified Display

The profiles can either be displayed in full detail, or simplified. There are four different display levels. The simplest display (rectangles) reduces the file size to 1/15th, and the working speed increases correspondingly.

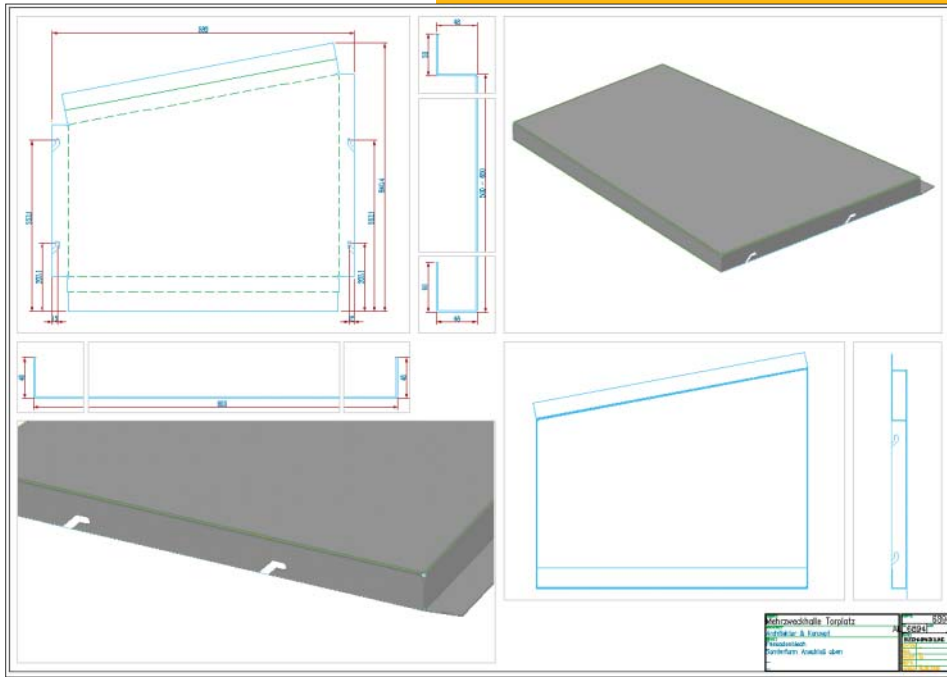

The advantages of the sheet editing program are summarized below:

- Any primary surfaces, folds, processes, separations and types of joint.
- Sheet generation by accepting a 2D cross-section or directions in a dialog box.
- Continuous visual checks via the 3D viewer with zoom/pan functions.
- Development computation via factor tables as is used in metal construction.
- Sheets are managed in libraries (order, partial order, etc.).
- Development produced automatically in DXF format for NC machine control.
- Fully compatible to ATHENA 3D.
- No procurement of additional "sheet-development software" is required unless the processing involves extremely complex metal sheets.

The function "Array Division" facilitates the division of any area into uniform rectangles with a defined starting point. This function is very versatile in application. Typical fields of application are for example, element façades, profiled sheet-metal façades, double floorboards, wall panels, ceiling panels and much more.

The properties in detail:

- The size and rotation angle of the rectangles can be freely selected.
- An outer space, which is not to be filled, can be defined as a boundary
- The gap width can be specified separately for horizontal and vertical gaps.
- Overlapping of the rectangles by entering a negative number for the gap width.
- In the border region the rectangles are cropped.
- The rectangles can be generated hatched as an optional representation.

For output options there are Array, List and Contours:

- "Array" places the defined array into the boundary contour.
- "List" produces a table with the number and cut size of the rectangles.
- "Contours" outputs the contour of the cut elements.

ARRAY DIVISION

M	Breite	Höhe	Fläche	Form	
mm	mm	mm	m ²		
10	500,0	500,0	0,250	/	
1	500,0	500,0	0,250	/	
1	500,0	500,0	0,250	<	
2	500,0	496,5	0,249	/	
2	500,0	500,0	0,249	/	
1	500,0	500,0	0,240	/	
1	500,0	500,0	0,239	/	
1	500,0	500,0	0,229	/	
1	500,0	500,0	0,203	/	
1	500,0	500,0	0,183	/	
1	418,9	500,0	0,178	/	
1	500,0	357,6	0,162	/	
4	500,0	300,0	0,150	/	
2	500,0	271,1	0,136	/	
1	252,1	500,0	0,126	/	
1	500,0	243,7	0,105	/	
2	184,5	500,0	0,092	/	
19	185,5	500,0	0,079	/	
20	1	277,5	300,0	0,078	/
21	1	377,9	377,9	0,071	/
22	1	278,3	300,0	0,071	/
23	1	377,9	271,1	0,066	/
24	1	178,3	500,0	0,051	/
25	1	184,5	271,1	0,050	/
26	1	252,1	500,0	0,047	/
27	1	301,0	496,5	0,040	/
28	1	80,0	427,8	0,034	/
29	1	213,7	353,6	0,030	/
30	1	500,0	115,5	0,027	/
31	1	183,7	496,5	0,025	/
32	1	72,2	500,0	0,023	/
33	1	115,3	239,7	0,021	/
34	1	15,6	145,6	0,001	/
50			7,640		

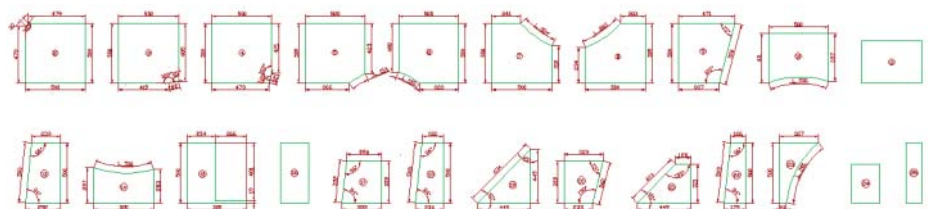

ENGINEERING

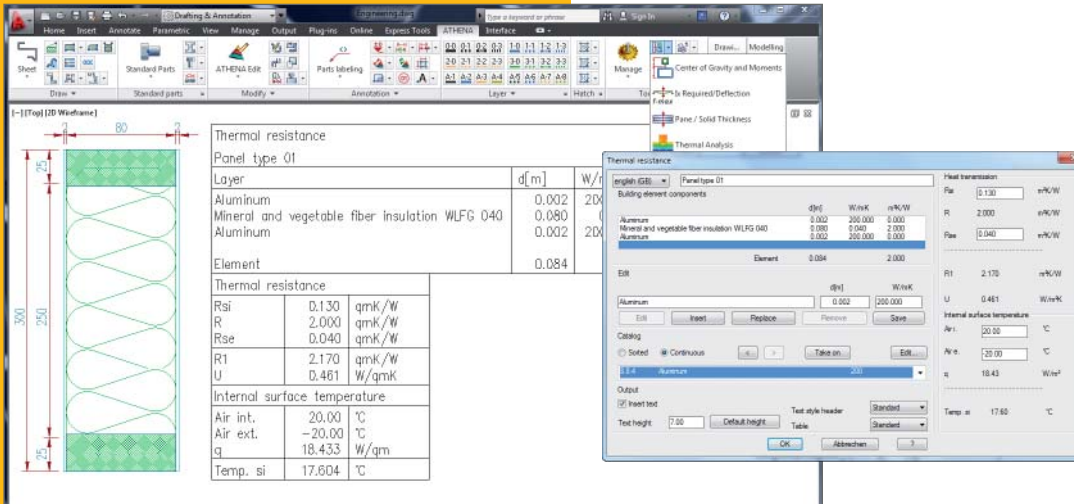

Thermal resistance

Establishment of thermal resistance values of chosen assemblies. The assemblies can be made of several layers (materials), which can be chosen from an freely extendable library.

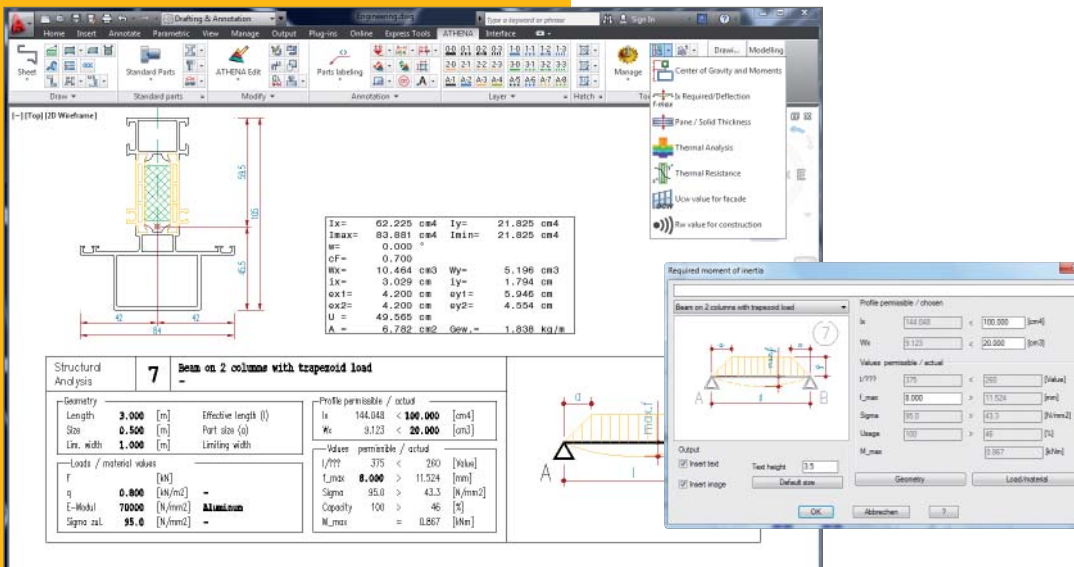

Required moment of inertia / deflection

Calculation of the required moment of inertia, the maximum deflection and maximum moment for a beam under 18 different load cases incl. collapsing verification. A results table can be inserted, with a diagram of the load case if required.

Centre of Gravity and moments

This command calculates the center of gravity, moments of force, centroid axes, radius of inertia, cross-section information such as area, external outline and the weight of one or more profiles. The center of gravity is marked and automatically dimensioned. This is ideal for the iterative process of creating custom project-specific profiles for specific aesthetic or strength parameters.

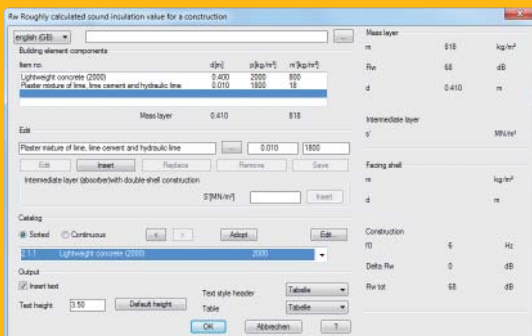

Rw - Estimated sound insulation factor

With this routine the sound insulation factor can be roughly determined for a construction. A classical construction consists of a mass layer (e.g. masonry), an intermediate layer (absorber) and a facing shell. A results table can be optionally inserted into the drawing.

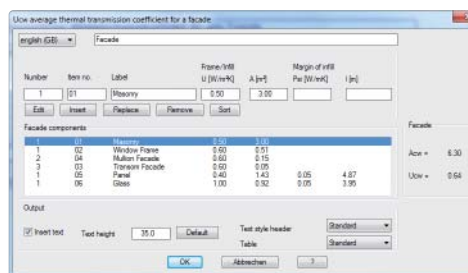

Ucw - Mean thermal transmission coefficient

With this command the mean thermal transmission coefficient of a window or a facade can be calculated. A results table can be optionally inserted into the drawing.

Panel / solid thickness calculation

Thickness calculation for a panel or solid body under a defined loading case. The Bach plate formula is used as a basis for the computation.

Thermal-hygro analysis

ATHENA includes a light version of flixo, the leading technical software for thermal bridge analysis and reporting (isothermal computation). Now thermal bridges can be detected at the planning stage and eliminated through changes in design.

The special feature with the integration of flixo in ATHENA: A detail drawing produced in ATHENA can be transferred to flixo in one working step. Here areas and materials (where known) are recognized and arcs are converted into polygons. Material changes or assignments can still be made in the flixo dialog box. After entering the internal and external temperature, a temperature computation is carried out and inserted into the ATHENA drawing.

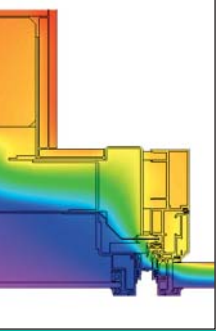

The previously time taken for the transfer of a detail drawing produced in CAD programs into the "Isothermal program" could easily amount to 1.5 hrs. plus the same time for modifications to the detail. The possibility of automatic transfer now reduces the time to the press of a key.

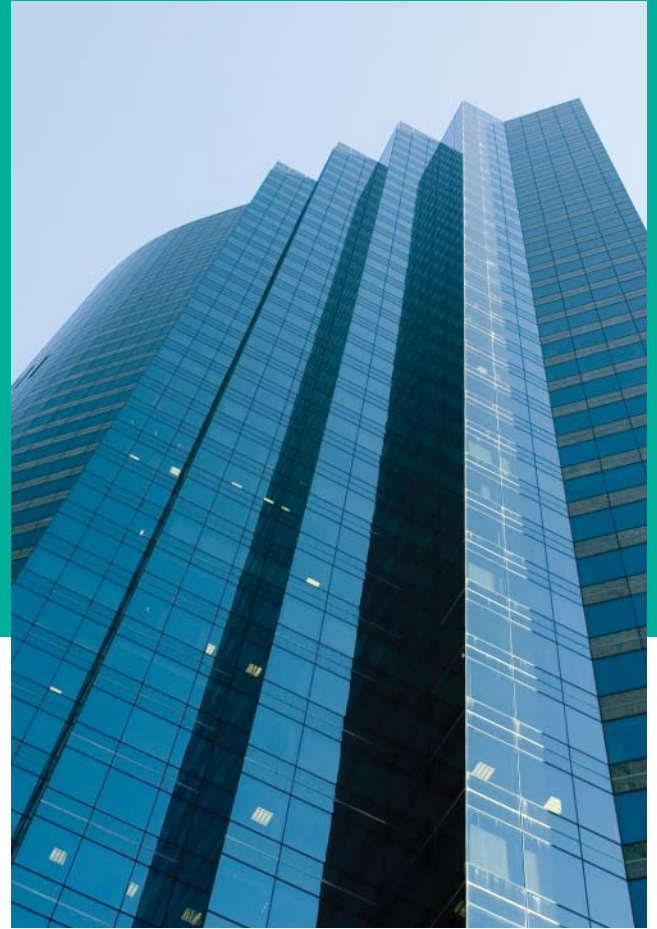

INTERFACES

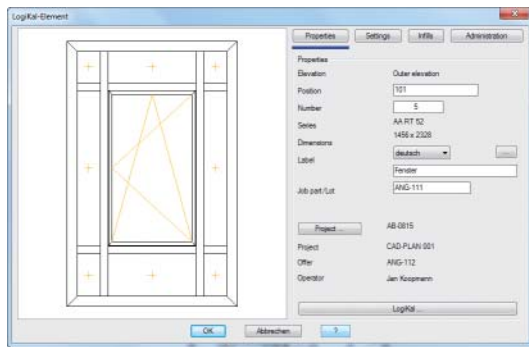

Interface to LogiKal

The ATHENA interface to LogiKal from Orgadata enables LogiKal profile master data to be used for the intelligent composition of profile assemblies in ATHENA.

The interface offers the function of composing a cross-section of a profile assembly (e.g. mullion, press-on profile and cover section) with LogiKal master data directly in ATHENA in a dialog box and importing it into the ATHENA bar assembly manager. In ATHENA these profile assemblies can be used without restriction for the 2D and 3D design, precisely as for static calculations and physical building examinations.

The LogiKal range of functions for automatic profile combination takes full effect via the interface. The additional profiles suitable for a selected profile are suggested in the dialog box and positioned at the intended location. In this way LogiKal can be used as a rule-based system library in ATHENA.

The bidirectional design of the interface facilitates the transfer of ATHENA constructions, e.g. of 3D models, to LogiKal for further processing, for additions or evaluations. Furthermore, the evaluations can also be implemented via the LogiKal functionality directly in ATHENA.

A new feature is an ATHENA command with which projects already present in LogiKal can be imported into ATHENA. These objects are held in ATHENA as copies and changes are also effective there. The objects can be output in ATHENA and no return to LogiKal is necessary.

Interface to ERPlus

ATHENA has an interface to ERPlus (ERP software from T.A. Project) with which 3D bars of 3D models, including appended assemblies, and 3D infills can be output to an XML file that can then be read in by ERPlus. Furthermore, article numbers of standard parts used in a drawing can also be passed on.

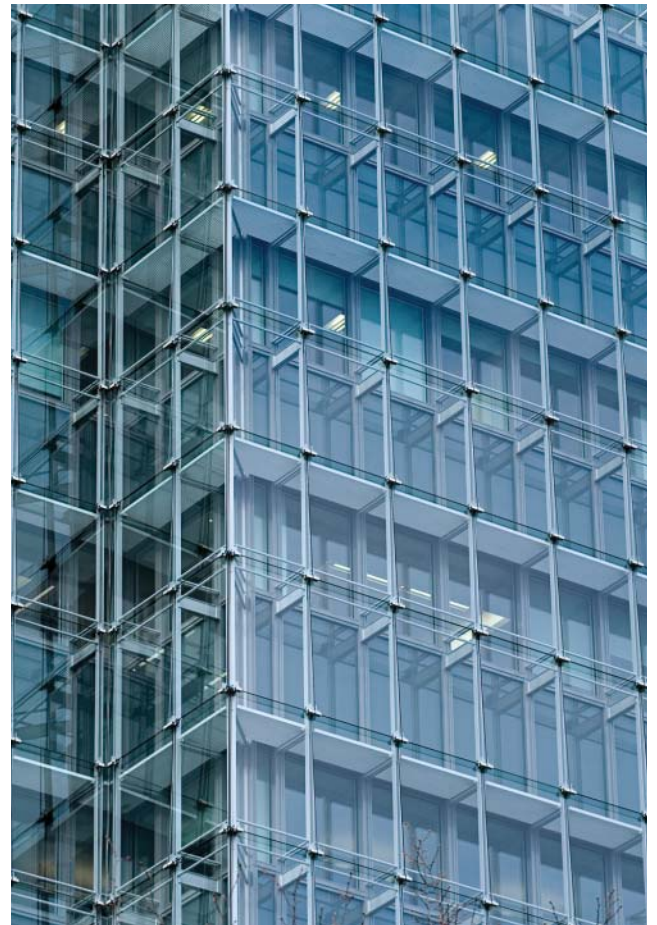

CAD-PLAN sales network worldwide:

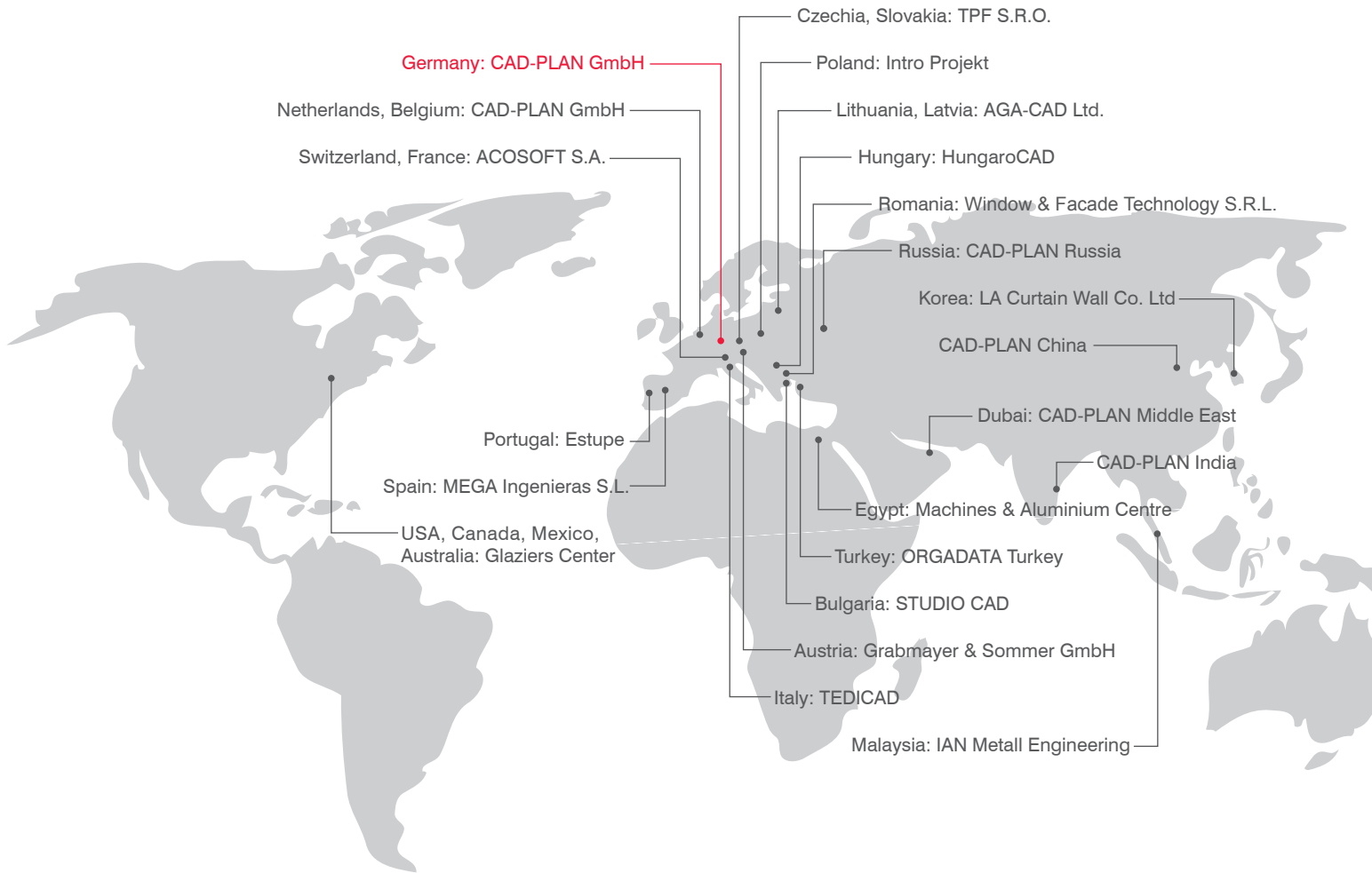

ATHENA - the solution for curtain wall design and façade engineering.

- Independent of profile system
- Easy to learn
- With a high general validity
- For engineering designs, i.e. not just drawings, but also for calculations (structural analysis, isothermals, etc.).
- Excellent list of references!
- Leads the market for design programs for metal construction under AutoCAD, therefore a sound investment.

System requirements

- AutoCAD 2010 to 2012
- AutoCAD Architecture 2010 to 2012
- AutoCAD Mechanical 2010 to 2012

Operating system:

Windows XP prof., Windows Vista or Windows 7

Hardware:

ATHENA requires the same hardware configuration as AutoCAD.

AutoCAD – registered trade mark of Autodesk Inc.
Windows XP, Vista, 7, MS-Excel – registered trade mark of Microsoft Inc.

ATHENA is independent of language. A change of language is possible even during the design. The following languages are available:

- German
- English
- French
- Italian
- Dutch
- Spanish
- Czech
- Polish
- Russian
- Romanian
- Chinese

CAD-PLAN GmbH
Frankfurter Str. 59-61
63067 Offenbach
Germany

Tel. +49-69-800 818-0
Fax +49-69-800 818-18

info@cad-plan.com
www.cad-plan.com

CAD-PLAN

